

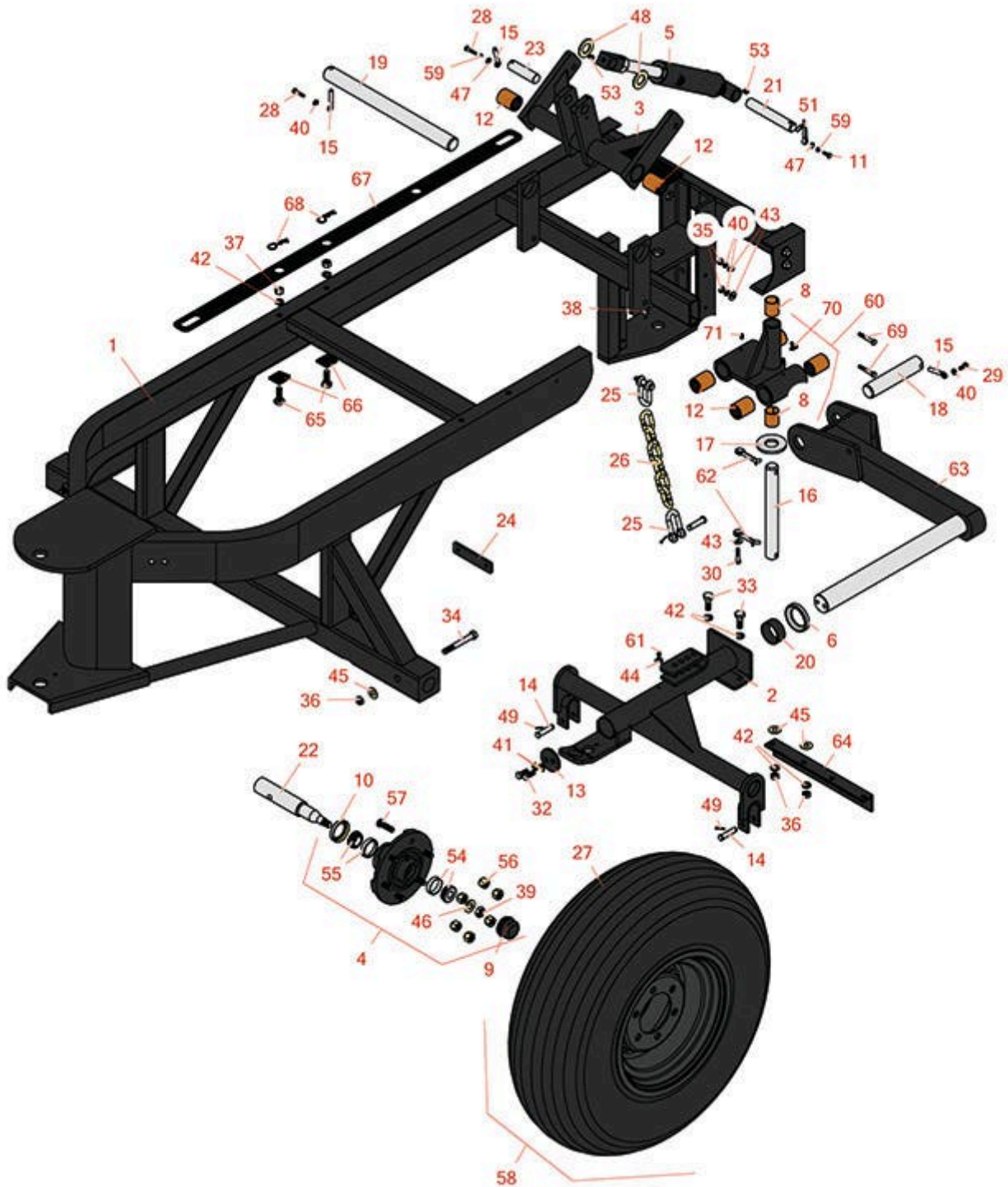

Replaces R&R Products Power Lift 7180GD Parts

Pull Frame
Main Frame



All original equipment manufacturers names and part numbers are used for identification purposes only, and we are in no way implying that our products are original equipment parts. Prices subject to change without notice.



Replaces R&R Products Power Lift 7180GD Parts

Pull Frame
Main Frame



Item No	R&R Part No.	OEM Part No.	Description	Qty Req	Order Quantity
1	R116657		Main Frame	1	
2	R5000622	R122409	Carrier Frame Assy	2	
3	R122413		Bell Crank Assy	1	
<i>Tech Note: Includes R550344 & R302-5:</i>					
4	R940001		Hub Assy	2	
5	R163215		Hydraulic Cylinder	1	
5	R500798	R502798	Seal Kit - Fits R130210 Cylinder	1	
6	R269005		Ring - Spacer 1/2	2	
8	R307121		Bushing - Bronze	2	
9	R314626		Hubcap - Heavy Duty	2	
10	R314627		Seal - Spindle	2	
11	R321-4	400108, R01-150-1030, R01-178-0406, R20-3-AGD, R3222-1, R400108	Bolt - Hex HD 1/4-20 x 3/4	1	
12	R550344	R342022	Bushing - Formed 1.5 x 1.625 x 2	4	
13	R342028		End Cap	2	
14	R343870		Clevis Pin - 1/2 x 2	4	
15	R346091	R364091	Pin - Retainer	3	
16	R363164		Pin - Front Pivot	1	
17	R363166		Washer - 1-1/4	1	
18	R363168		Pin - Front Lift Cylinders	2	

All original equipment manufacturers names and part numbers are used for identification purposes only, and we are in no way implying that our products are original equipment parts. Prices subject to change without notice.



Replaces R&R Products Power Lift 7180GD Parts

*Pull Frame
Main Frame*



Item No	R&R Part No.	OEM Part No.	Description	Qty Req	Order Quantity
19	R363170		Pin - Bell Crank	1	
20	R363189		Spacer - 1 in	2	
21	R363194		Pin - Front Lift Cyl	1	
22	R363227		Spindle - Wheel	2	
23	R363228		Pin - Front Lift Cyl	1	
24	R363232		Plate - Shim	2	
25	R363252		Shackle - Chain	4	
26	R363256		Chain - 3/8 x 6 Link	2	
27	R363263		Tire - 11L-15 (8 Ply) Farm Utility	2	
28	R400112	R400114	Bolt - Hex HD 1/4-20 x 1-1/4	1	
29	R400184	400184	Screw - 5/16-18 x 3/4 Hex	3	
30	R400192		Bolt - Hex HD 5/16-18 x 1-1/2	1	
32	R400370		Bolt - Hex HD 7/16-20 x 1 GR5	4	
33	R400408	325-6, R01-150-0090, R01-178-0812, R20-87-AD, R20-87-AGD, R20-87-AGF, R3226-2, R325-6, R513376, R513378	Bolt - Hex HD 1/2-13 x 1-1/2	4	
34	R400422		Bolt - Hex HD 1/2-13 x 4 GR5	2	

All original equipment manufacturers names and part numbers are used for identification purposes only, and we are in no way implying that our products are original equipment parts. Prices subject to change without notice.



Replaces R&R Products Power Lift 7180GD Parts

*Pull Frame
Main Frame*



Item No	R&R Part No.	OEM Part No.	Description	Qty Req	Order Quantity
35	R443106	3218-2, 443106, R01-188-0518, R09003, R22-12-AJD, R32111-4, R3217-4, R3217-6, R513295, R513412, R915112P, R915978, R915979	Nut - 5/16-18 Y/Zinc Plated	2	
36	R443118	R01-188-0813, R22-15-AJD, R3217-9	Nut - 1/2-13 Zinc	6	
37	R443818	R01-191-0813, R3218-18, R3218-5	Nut - 1/2-13 Hex Jam Zinc	2	
38	R444718	444718	Nut - 5/16-18 Center Lock YZ	1	
39	R445672		Nut - Hx Slotted 5/8-18	2	
40	R446136	446136, R446134	Washer - Lock 5/16 Zinc	5	
41	R446146	446148, R446148	Lock Washer - 7/16	4	
42	R446154	R446152	Washer - Lock 1/2	8	

All original equipment manufacturers names and part numbers are used for identification purposes only, and we are in no way implying that our products are original equipment parts. Prices subject to change without notice.



Replaces R&R Products Power Lift 7180GD Parts

*Pull Frame
Main Frame*



Item No	R&R Part No.	OEM Part No.	Description	Qty Req	Order Quantity
43	R453009	3256-3, R01-166-0400, R24-10-BD, R24-9-AD, R24H1136, R32-9650, R3256-2, R3256-23, R3256-67, R3290-217, R3556-3, R4-2390, R452006, R7-0152	Washer - Flat 5/16 SAE	3	
43	R310266	3256-3, R09056, R452004	Washer - Flat 5/16 USS	3	
44	R453011	3256-24, 453011, R01-166-0100, R01-166-0120, R01-166-0270, R01-166-0500, R01-166-0600, R01-166-0620, R132-4593, R237-12, R24-10-AD, R24-11-AD, R24-11-BD, R24-12-AD, R24-12-BD, R30-9310, R32-8190, R3256-24, R3256-3, R3256-36, R3256-4, R47-9950	Washer - Flat 3/8 SAE Y/Zinc	2	

All original equipment manufacturers names and part numbers are used for identification purposes only, and we are in no way implying that our products are original equipment parts. Prices subject to change without notice.



Replaces R&R Products Power Lift 7180GD Parts

Pull Frame
Main Frame



Item No	R&R Part No.	OEM Part No.	Description	Qty Req	Order Quantity
45	R453017	3256-26, R01-166-0050, R01-166-0240, R01-166-0800, R24-13-AD, R24-14-AD, R32-8110, R3256-6, R452012, R69-8980	Washer - Flat 1/2	0	
46	R453020	R3256-59	Washer - 5/8 SAE Flat Z	2	
47	R453023	R3256-1, R3256-72	Washer - Flat 1/4	2	
48	R455004		Washer - Flat 1 in SAE	2	
49	R460028	R01-151-0230, R28-10-D, R3272-7, R48-7530	Pin - Cotter 1/8 x 1	4	
51	R460068		Pin - Cotter 1/4 x 2	2	
53	R471219	471219, R30-8360, R302-2, R302-24, R302-31, R471231, RJD7759, RJD7798	Zerk - Grease	2	
53	R471227		Fitting - Grease 1/4-28 45 Deg	3	
54	R500534	R1-633585, R2208006	Bearing - with Cup	2	
55	R500535		Bearing - with Cup	2	
56	R590302		Nut - Wheel Hub	12	
57	R590303		Bolt - 1/2-20 x 1 7/8	12	

All original equipment manufacturers names and part numbers are used for identification purposes only, and we are in no way implying that our products are original equipment parts. Prices subject to change without notice.



Replaces R&R Products Power Lift 7180GD Parts

Pull Frame
Main Frame



Item No	R&R Part No.	OEM Part No.	Description	Qty Req	Order Quantity
58	R940002		Tire & Wheel	2	
59	R3253-3	446130, R01-166-0070, R01-166-0410, R23-9-GD, R24-7150, R352-167, R446128, R446130	Washer - Lock 1/4	2	
60	R122407		Front Pivot Assy	1	
<i>Tech Note: Includes R307121 & R550344:</i>					
62	R460088		Pin - Cotter 3/8 x 2-1/2	1	
63	R122414		Arm Assy - Front - RH	1	
63	R122415		Arm Assy - Front - LH	1	
64	R363197		Cam - Front Arm - Black	2	
65	R363298		Bolt - Hex HD Special 1/2-13	8	
66	R319598		Washer - Bevel 1/2 - Black	8	
67	R337964		Transport Bar - Wing Units	1	
68	R460328		Hairpin Cotter	2	
69	R400196		Bolt - Hex HD 5/16-18 x 2	2	
70	R302-40	R302-13	Fitting - Grease	1	

All original equipment manufacturers names and part numbers are used for identification purposes only, and we are in no way implying that our products are original equipment parts. Prices subject to change without notice.



Replaces R&R Products Power Lift 7180GD Parts

*Pull Frame
Main Frame*



Item No	R&R Part No.	OEM Part No.	Description	Qty Req	Order Quantity
71	R302-5	R173-0, R21-6010, R255825, R302-37, R302-47, R302-57, R302-58, R302-6, R31-0300, R32-9660, R471214, R471223, R471226, R60-0800, R62-3880, R92-4181, RJD7797, RJD7842, RJD7844, RM0004	Fitting - Grease	2	

All original equipment manufacturers names and part numbers are used for identification purposes only, and we are in no way implying that our products are original equipment parts. Prices subject to change without notice.