

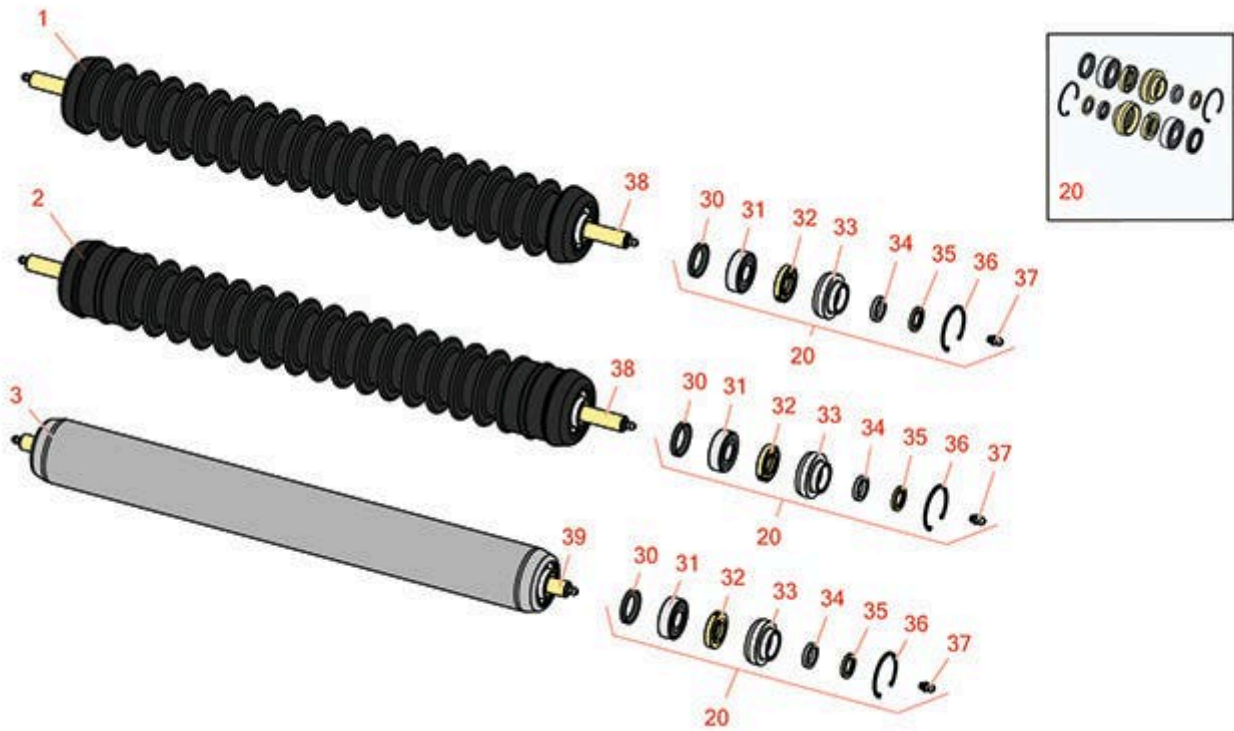

Replaces Toro Reelmaster 5200D Parts

Cutting Unit - Model 03527 & 03528
Rollers



All original equipment manufacturers names and part numbers are used for identification purposes only, and we are in no way implying that our products are original equipment parts. Prices subject to change without notice.



Replaces Toro Reelmaster 5200D Parts

Cutting Unit - Model 03527 & 03528
Rollers



Item No	R&R Part No.	OEM Part No.	Description	Qty Req	Order Quantity
---------	--------------	--------------	-------------	---------	----------------

R&R Rollers

1	R100-7132	100-7132	Roller - Grooved Cast Steel	0
---	------------------	----------	-----------------------------	---

Tech Note: Constructed with cast steel body and a through shaft. This roller uses greasable ball bearings.:

2	R104-3369	104-3369	Roller - Grooved Cast Steel Shoulder	0
---	------------------	----------	--------------------------------------	---

Tech Note: Constructed with cast steel body and a through shaft. This roller uses greasable ball bearings. Outer two grooves on each end are shallow.:

3	R100-2536	100-2536	Roller - Smooth Tubular Steel	0
---	------------------	----------	-------------------------------	---

Tech Note: Constructed with a through shaft, this heavy duty roller uses greasable ball bearings.:

Overhaul Kits

20	R106-9606	106-9606	Overhaul Kit - Roller	0
----	------------------	----------	-----------------------	---

Tech Note: Include 2 ea: R343667 Bearings, R253-70 Seals, R32120-62 Retaining Rings, R93-1251 Seals, R93-1252 Seals, R93-2931 Washers, R93-3007 Seals:

Other Parts Available

30	R93-3007	93-3007	Seal	2
----	-----------------	---------	------	---

31	R343667	109966, 251-6, 38-7820	Bearing - Ball	2
----	----------------	------------------------------	----------------	---

32	R93-1251	93-1251	Seal	2
----	-----------------	---------	------	---

33	R93-1252	93-1252	Seal - Outer	2
----	-----------------	---------	--------------	---

34	R253-70	253-70	Seal	2
----	----------------	--------	------	---

35	R93-2931	93-2931	Washer - Roller Seal	2
----	-----------------	---------	----------------------	---

36	R32120-62	32120-62	Ring - Retaining	2
----	------------------	----------	------------------	---

All original equipment manufacturers names and part numbers are used for identification purposes only, and we are in no way implying that our products are original equipment parts. Prices subject to change without notice.



Replaces Toro Reelmaster 5200D Parts

Cutting Unit - Model 03527 & 03528
Rollers



Item No	R&R Part No.	OEM Part No.	Description	Qty Req	Order Quantity
37	R302-5	21-6010, 302-11, 302-37, 302-47, 302-5, 302-57, 302-58, 302-6, 31-0300, 32-9660, 60-0800, 62-3880, 92-4181	Fitting - Grease	2	
38	R104-1806	104-1806	Shaft - Roller	1	
39	R100-2538	100-2538	Shaft - Roller	1	

All original equipment manufacturers names and part numbers are used for identification purposes only, and we are in no way implying that our products are original equipment parts. Prices subject to change without notice.